



EQUIPMENT



Drill / Driver



Silicone Gun + appropriate sealant

TOOLS



Drill Bit 3mm or 1/8"



Masonry Drill Bit 14mm
*** recommend diamond coated bit for tiled surfaces



Driver Phillips No. 2

IMPORTANT INFORMATION

- ⚠ 1. Product contains a powerful magnet. Avoid contact with metal foreign bodies prior to installation. Keep well clear of electronics and electrical equipment.
 - 2. Carefully read installation Instructions prior to installation. Installing contrary to these instructions risks damage to your floors and door
- Carpeted surfaces: Allow sufficient clearance of carpet thread and pile when drilling hole into floor to avoid wrapping or binding to drill bit
- Tiled surfaces: It is recommended to use a diamond coated drill bit to avoid chipping and damage of tiles

INSTALLATION INSTRUCTIONS

- A** 1. Remove components from box, leave magnet in packaging for now



- B** Mark Pin location on ground
1. Open door to desired 'stop position'
 2. Mark location on floor for pin as per diagram below

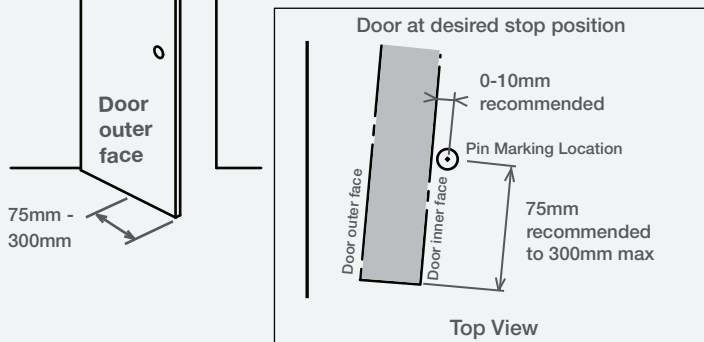

- F** Position Striker Housing Height

1. Adjust height of Striker Housing to ensure once fitted Strike Zone Height is within range shown. Slotted holes will allow for some adjustment after fixing

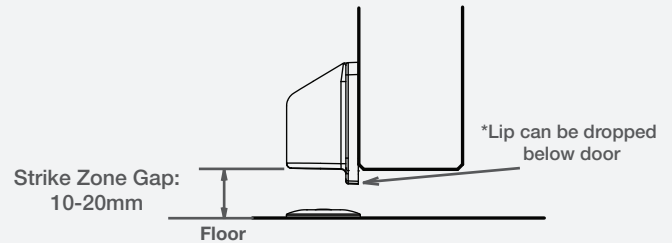

- G** Mark screw positions and drill pilot holes

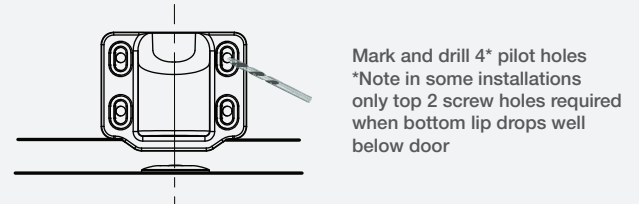

- H** Assemble Striker

1. Carefully unwrap Magnet from packaging
 2. Place immediately into Housing, then fit Backing Plate
- ⚠ Warning. Powerful magnet, avoid any steel object within at least 200mm

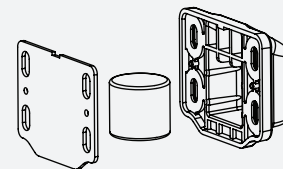

- C** Install Pin into floor
1. Drill 14mm hole, 50mm deep.
 2. Trial fit Sleeve into hole and ensure it is a loose fit. Redrill if required
 3. Clean hole and area
 4. Apply silicone to Sleeve and insert into hole
 5. Once dry, drop pin into Sleeve, chamfered edge first

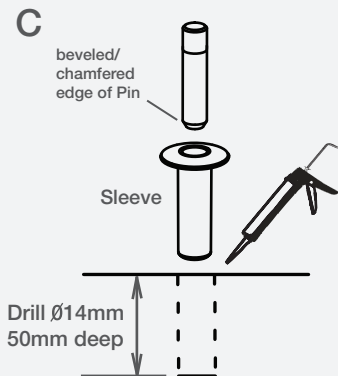

- E** Marking-out Striker Position
1. Align door to Pin position on floor, and mark centre for the Striker Housing on the door

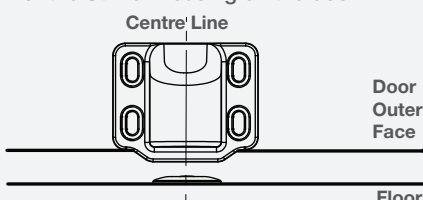

- I** Fix Striker to Door & Test

1. Fix Striker to door with screws, and tighten appropriately
- **Note Striker Housing is intended to hang below door to achieve desired Strike-zone gap. Bottom screws may not be used in some installations

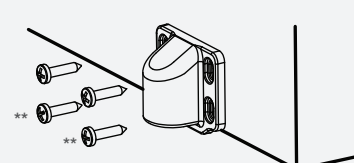

2. Test function of the door stop. Adjust Height of Striker as required to achieve optimal operation.